



AKRAPOVIC SLIP-ON EXHAUST SYSTEM for the KAWASAKI ZZR1400 (2006 - 2007)

Congratulations on purchasing an Akrapovic exhaust system. Please read these installation instructions carefully. If you have any trouble installing the system please contact your authorized dealer!

IMPORTANT INFORMATION

Exclusion of Certain Liability

1. The manufacturer, importer or dealer shall not be liable for any incidental damage including personal injury or any other damages caused by improper installation or operation of the Akrapovic exhaust system. When installing the Akrapovic exhaust system be careful that the exhaust system does not touch other parts sensitive to high temperature.
2. Akrapovic makes no representation or warranties with regard to damage caused by the improper installation, use and maintenance of the Akrapovic exhaust system. The warranty is limited to defects recognized by our technical department and to normal use, and excludes items subject to normal wear (gaskets and damping wool). The guarantee is void in case of accident, modification, improper or competition use.
3. Do not attempt to install the Akrapovic exhaust system on a motorcycle for which it was not made or tested by Akrapovic.
4. When the exhaust system gets very hot during operation, be careful not to burn yourself on the exhaust system or parts which are in direct contact with it, even when the motor is not running. Also protect other people, especially children, from the injuries mentioned above.
5. In some cases Akrapovic exhaust system kits contain chemical products (ceramic anti-seizing grease; bolt sealant). Handle with care, do not inhale or swallow. Avoid excessive contact with skin, eyes or mucous membranes. Keep out of reach of children.
6. Technical specifications of Akrapovic exhaust systems and related products subject to change without notice.

Trademarks

The Akrapovic Exhaust System Technology logo is a registered trademark of Akrapovic d.o.o.

Akrapovic website

Information about Akrapovic exhaust systems and related products is available on the Akrapovic website at:

<http://www.akrapovic-exhaust.com/>

Copyright

No part of the Akrapovic exhaust system or its documentation may be reproduced or distributed in any form or by any means without the prior written authorization of the Akrapovic company.

© Akrapovic, d.o.o. All rights reserved.

Symbols

The following symbols are used throughout these installation instructions:



 **USE BOLT SEALANT;** Apply 3 to 4 small drops of bolt sealant onto the cleaned and degreased threads before tightening bolts. **WARNING! Avoid contact with skin, eyes and mucous membranes. Do not inhale fumes. Keep out of the reach of children.**

 **USE ANTI-SEIZING GREASE (white tube);** Prevents seizing, corrosion and excessive wear between the titanium components of your exhaust system. **WARNING! Avoid eye contact. Avoid excessive skin contact. Keep out of the reach of children.**

 **USE ANTI-SEIZE LEAD-FREE COPPER PASTE (black tube);** Provides trouble-free and long-lasting protection against seizing, corrosion and rusting of bolts, threaded ends, nuts, joints, etc. Also protects against vibration, wear and impact. **WARNING! Avoid eye contact. Avoid excessive skin contact. Keep out of the reach of children.**

INSTALLATION INSTRUCTIONS

 BEFORE INSTALLING CHECK SCHEMATIC OF THE EXHAUST SYSTEM!

! IF ANY ITEMS IN THE AKRAPOVIC EXHAUST SYSTEM PACKAGE ARE MISSING PLEASE CONTACT YOUR AUTHORIZED DEALER. KEEP THE SCHEMATIC FOR FUTURE REFERENCE.

! THESE INSTALLATION INSTRUCTIONS MUST BE READ CAREFULLY IN ORDER TO ENSURE PROPER INSTALLATION AND OPERATION OF THE AKRAPOVIC EXHAUST SYSTEM.

! THE EXHAUST SYSTEM CAN BE EXTREMELY HOT. ALLOW THE MOTORCYCLE TO COOL DOWN BEFORE BEGINNING INSTALLATION.

 WE ADVISE YOU TO LEAVE INSTALLATION TO A QUALIFIED SERVICEMAN. IMPROPER INSTALLATION MAY RESULT IN A SHORTER LIFETIME OF THE EXHAUST SYSTEM AND/OR DAMAGE TO THE MOTORCYCLE.



T-handle 8mm wrench
T-handle 3mm three hexagon key wrench
T-handle 5mm three hexagon key wrench
T-handle 6mm three hexagon key wrench
T-handle swiveling 12mm wrench
Combination 14mm wrench
Spring puller

REMOVAL OF STOCK EXHAUST SYSTEM:

1. Unscrew the bolts from the metal clamp at the muffler - collector joint, link-pipe bracket and muffler sub-frame bracket. Remove the muffler. Perform the process on both sides of the motorcycle (**Figure 1, 2, 3, 4**).



Figure 1



Figure 2



Figure 3



Figure 4

INSTALLATION OF THE AKRAPOVIC SLIP-ON EXHAUST SYSTEM:

1. Coat the bolt and interior of the metal clamp with spring hook with Akrapovic anti-seize lead-free copper paste (black tube). Correctly attach the clamp with spring hook on the left stock collector outlet (**Figure 5, 6**). Coat the bolts and interior of the metal clamps with Akrapovic anti-seize lead-free copper paste (black tube) and correctly install them onto both link pipes (**Figure 7**). Slide both link pipes onto the stock collector and attach the (longer) spring on the left side link and link pipe bracket to frame using stock bolt, washer and nut (**Figure 8, 9, 10, 11**). Tighten the bolts of both link pipe clamps (**Figure 12**).



Figure 5

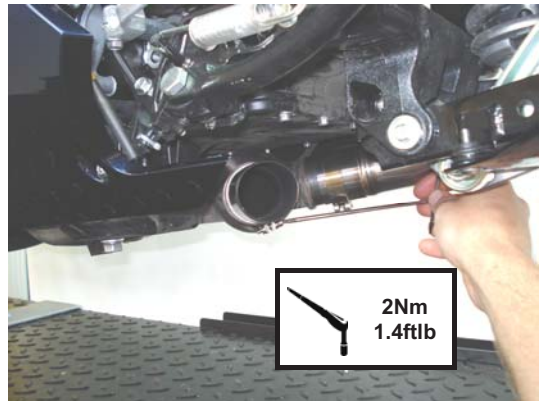

Figure 6



Figure 7



Figure 8



Figure 9



Figure 10

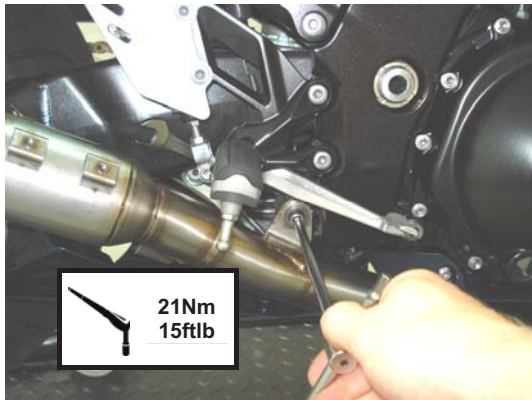

Figure 11

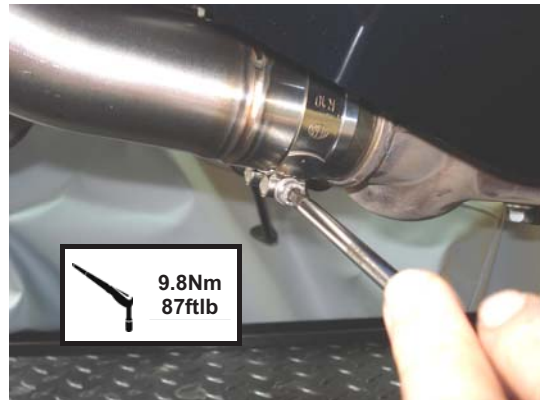

Figure 12

2. Correctly attach the catalytic converter heatshields on both link pipes (Figure 13, 14, 15, 16).



Figure 13

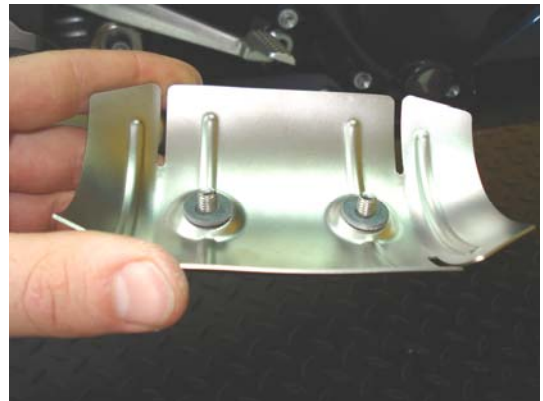

Figure 14

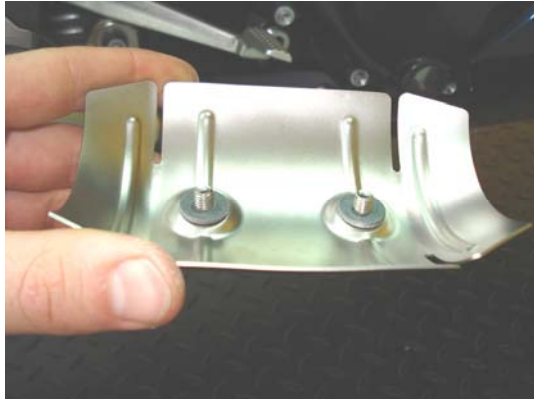

Figure 15

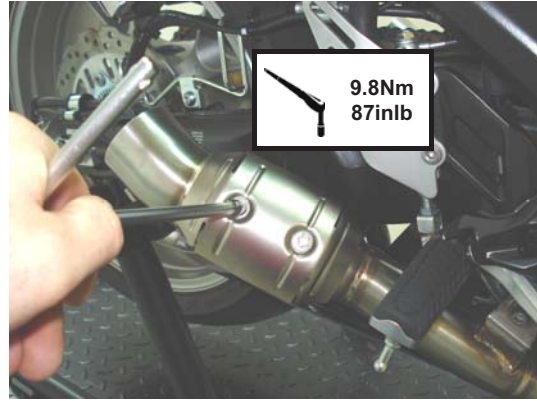

Figure 16

- Position both mufflers correctly and slide them onto the outlet side of the link pipes (Figure 17). Attach the (shorter) springs (Figure 18). Correctly position the carbon-fiber clamps (yellow stickers on the inner side of the motorcycle!) and slide them onto the mufflers (Figure 19). **WARNING:** open the clamps slightly wider than the diameter of the outer sleeve of the mufflers – do not scrape them along the mufflers outer sleeve! Be careful not to damage paint or any other part of the motorcycle during this process! Assemble the stock bolts, spacers, nuts and tighten the clamps as shown in figures (Figure 20). Make sure the mufflers or link pipes are not touching the frame or any other parts of the motorcycle.



Figure 17



Figure 18



Figure 19

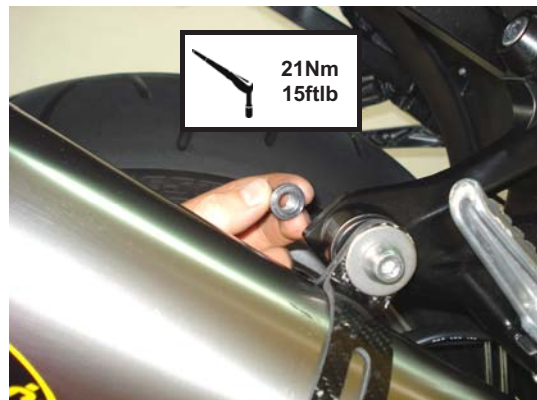

Figure 20

final installation:

1. Clean grease spots:
 - a. Muffler – titanium outer sleeve: use a soft cloth sprayed with a multi-purpose spray lubricant (WD-40 or equivalent).
 - b. Stainless steel link pipes and mufflers inlet and end caps: use a soft cloth sprayed with a contact cleaner, then wipe with a soft dry clothCleaning will prevent spots from burning onto the surface. Do not use aggressive chemical cleaners, because they can damage the sticker.
2. **WARNING: after running engine for 30 minutes, tighten the bolts on the Akrapovic carbon-fiber heat shields !**

Position of the correctly installed Akrapovic **SLIP-ON** system (Figure 21).



Figure 21

3. Check the operation of the brakes and suspension. Make sure all the bolts are sufficiently tightened. In case the exhaust system touches the cowling or other parts repeat the adjustment of the exhaust system or contact your authorized dealer.

! IT IS NORMAL IF WHITE SMOKE COMES OUT OF THE MUFFLER ON FIRST OPERATION.

! DO NOT STAND BEHIND THE MUFFLER ON FIRST OPERATION.

! DO NOT USE AUTOMOTIVE WHEEL CLEANERS OR ANY CLEANING PRODUCTS WHICH CONTAIN ACIDIC ADDITIVES TO CLEAN AKRAPOVIC EXHAUST SYSTEMS.

MAINTENANCE OF THE AKRAPOVIC EXHAUST SYSTEM

1. Clean the titanium exhaust components with a multi-purpose spray lubricant (WD-40 or equivalent), carbon fiber exhaust components with soft and dry cloth and stainless steel components with soft cloth sprayed with contact cleaner, then wipe with soft and dry cloth. Do not use aggressive chemical cleaners, because they can damage the sticker. A change in the color of the exhaust system is normal due to the high temperatures.
2. The wearing out of the muffler silencing material depends on the type of the engine and riding style. Contact your dealer/serviceman if visible changes appear on muffler's outer sleeve or the noise level is increased.
3. Periodically make sure all the bolts and springs are sufficiently tight.

KAWASAKI ZX-14 (ZZR 1400)/ SLIP ON, SP series exhaust system, model year: 2006 - 2007 / OPEN

**Product code: 106417 (SS-K14SO1-T)
106418 (SS-K14SO1-C)**

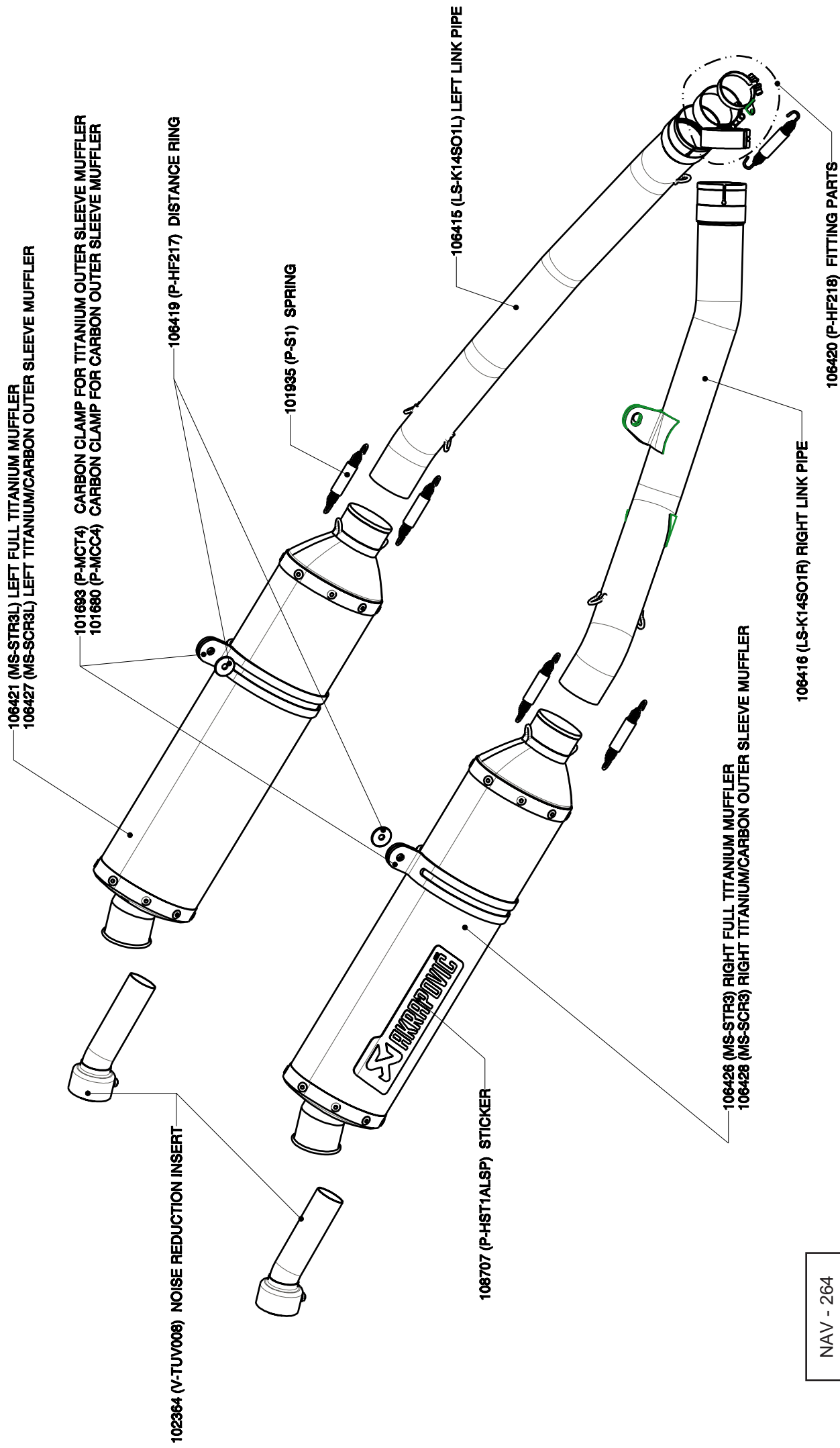

KAWASAKI ZZR 1400 (ZX-14) / SLIP ON exhaust system, model year: 2006 - 2007 / STREET LEGAL

Product code: SS-K14SO1C-HT

